









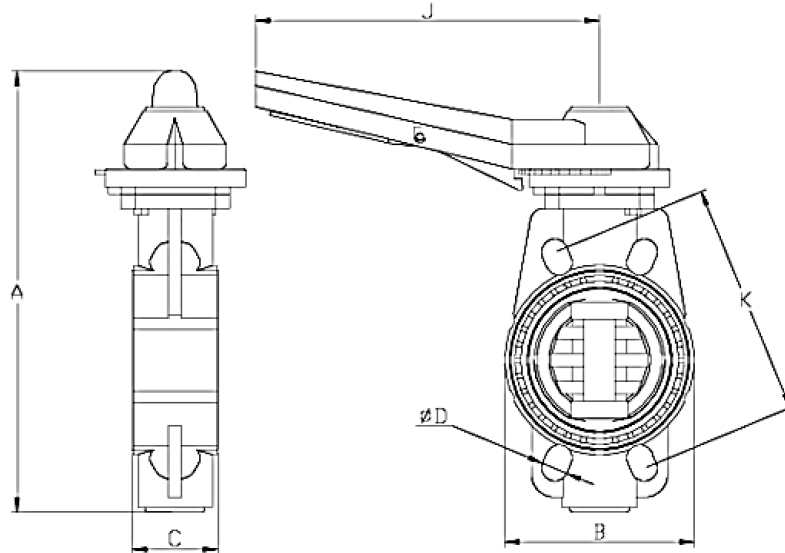

Everyvalve Ltd



Page 10	2021	Telephone : 01707-642018	Data sheet
 www.everyvalve.com	Butterfly Valve Wafer Type GFPP Body - EDPM Seal Catch Handle		 Sales@everyvalve.com



Eve Ref	Size	Weight	A	B	C	D	K	J	PN
10P09705	63	1116	264	136	50	18x4	125-145	235	PN10
10P09706	75	1116	264	136	50	18x4	125-145	235	PN10
10P09707	90	1648	288	130	57	18x8	146-160	235	PN10
10P09708	110	1856	308	152	60	18x8	178-190	235	PN10
10P09709	125	2100	344	170	62	18x8	190	270	PN10
10P09710	140	2360	364	187	65	18x8	210-216	270	PN10
10P09711	160	3024	386	214	69	22x8	235-241	270	PN10

					
Everyvalve Ltd 19 STATION CLOSE POTTERS BAR HERTS EN6 1TL TEL : 0044(0)1707642018 FAX : 0044(0)1707646340 http://www.everyvalve.com sales@everyvalve.com					
MANUFACTURER AND SUPPLIERS TO COMMERCIAL INDUSTRIES.					



Everyvalve Ltd

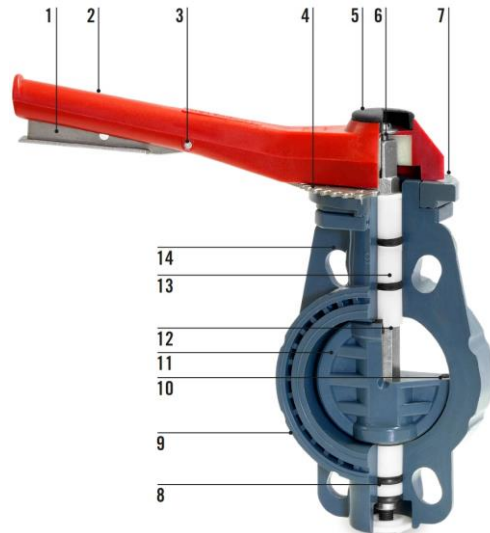

- 1. Trigger stainless steel A-2
- 2. GFPP lever
- 3. Bolt stainless steel A-2
- 4. Crown stainless steel A-2
- 5. Upper lid
- 6. Stainless steel A-2 fastening bolt and washer
- 7. GFPP crown support
- 8. EPDM o-ring
- 9. GFPP valve body
- 10. EPDM or VITON seal
- 11. GFPP Disc
- 12. Zinc-plated iron, SS A-2, SS A-4 shaft
- 13. POM guideway axis
- 14. Hole for bolt tightening

LOAD LOSS CURVES

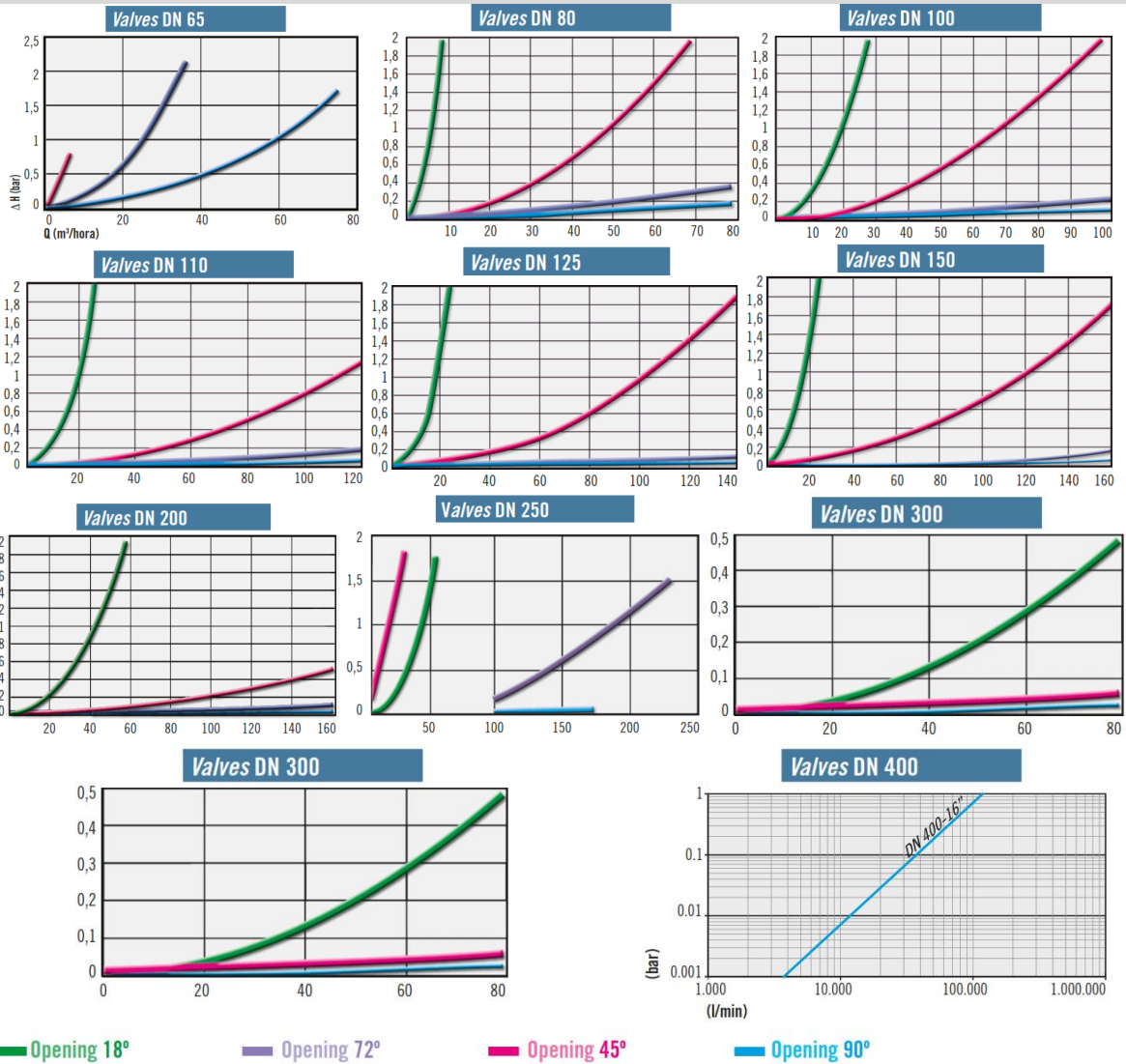



Everyvalve Ltd



AVERAGE TORQUE BUTTERFLY VALVES

MAX. TORQUE NO LUBRICATED		MAX TORQUE LUBRICATED	
Æ	Par N.m	Æ	Par N.m
63-75	16.00	63-75	11.00
90	38.00	90	27.00
110	40.00	110	30.00
125	64.00	125	53.00
140	68.00	140	56.00
160	76.00	160	50.00
200-225	98.00	200-225	64.00
250	150.00	250	100.00
315	240.00	315	200.00
400	750.00	400	650.00

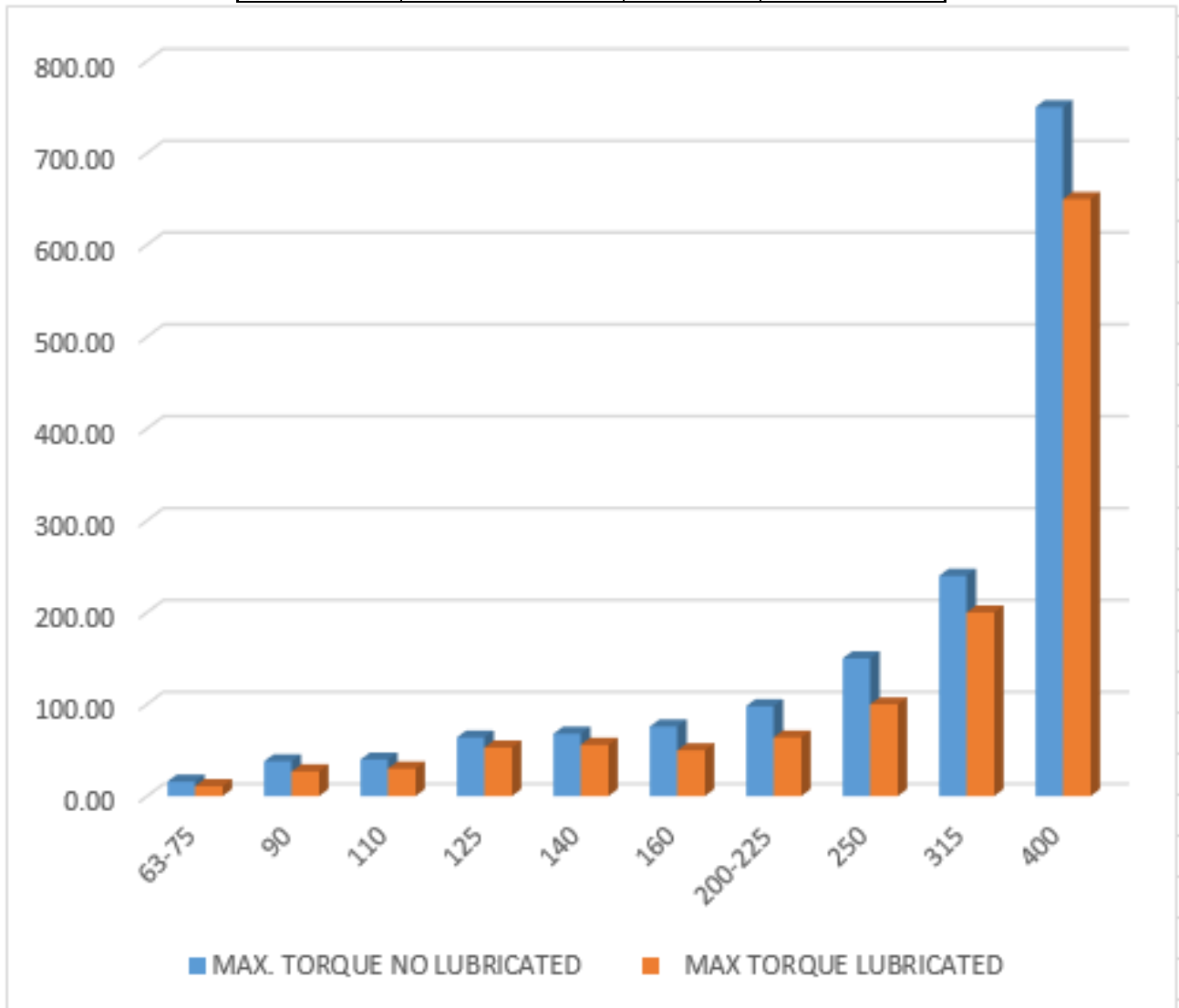

Everyvalve Ltd | 19 STATION CLOSE | POTTERS BAR | HERTS | EN6 1TL | TEL : 0044(0)1707642018 | FAX : 0044(0)1707646340 |
<http://www.everyvalve.com> | sales@everyvalve.com

MANUFACTURER AND SUPPLIERS TO COMMERCIAL INDUSTRIES.